

SWSL1212DC

Electric Driven Scissor Scissor-type Aerial Work Platform

SUNWARD

Dimension

Working height*		12m
A	Platform height maximum	10m
B	Platform height (stowed)	1.36m
C	Platform length	2.27m
	Slide-out platform extension deck	0.9m
D	Platform width	1.15m
E	Stowed height (rails up)	2.49m
	Stowed height (rails down)	1.95m
F	Overall length	2.47m
G	Overall width	1.17m
H	Wheelbase	1.87m
I	Ground clearance (stowed)	0.11m
J	Ground clearance (raised)	0.02m

Performance

Lift capacity	320kg
Lift capacity (extension deck)	113kg
Max. platform occupancy	2
Drive speed (stowed)	4.0km/h
Drive speed (elevated)	0.8km/h
Turning radius (inside)	0m
Turning radius (outside)	2.2m
Raise / lower speed	55s / 38s
Gradeability**	25%
Max. allowable working angle (lateral / longitudinal)	1.5° / 3°
Controls	Proportional
Wheel driver	DC motor front drive
Multiple disc brakes	Dual front wheel
Tires	381mm×127mm
Battery	4×6V/240Ah
Charger	24V/30A
Weight	2950kg

* Working height is equal to Platform height plus 2m.

** Climbing ability is suitable for driving on slopes; Refer to Operator Manual for slope level.

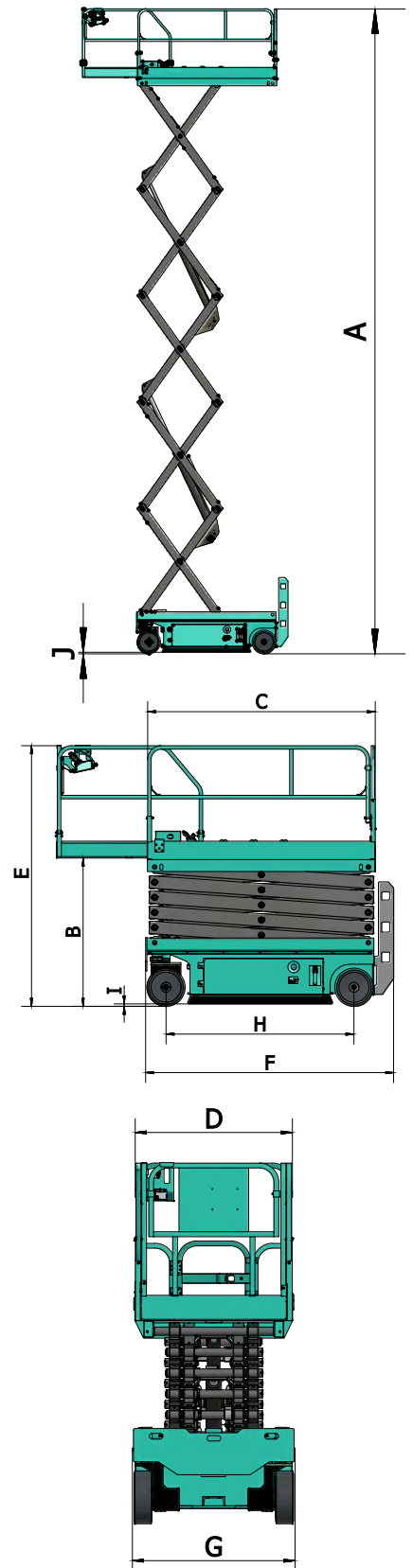

SWSL1212DC

Electric Driven Scissor Scissor-type Aerial Work Platform

Simmler *Vermietung Verkauf Reparatur*
Baumaschinen

Buechstr. 25, 8645 Jona 055 212 69 50
www.simmler.swiss



Standard features

◆ Proportional control	◆ Extended platform	◆ Folding guardrails platform	◆ Self-lock gate on platform
◆ Solid tire	◆ Hour meter	◆ Standard transport forklift hole	◆ Safety maintenance support rod
◆ Horn	◆ Flashing beacon	◆ Action beep	◆ DC motor drive
◆ Pit protection device	◆ Emergency descent system	◆ Emergency stop button	◆ Automatic brakes system
◆ Tilt sensor with alarm	◆ Charging protection system	◆ Fault diagnosis system	

Options features

◆ Air line to platform	◆ AC power to platform	◆ GPS tracking system	◆ Platform work lights
◆ Maintenance-free battery	◆ Lithium battery and management system	◆ Intelligent interconnection system	◆ Overload protection system

SUNWARD INTELLIGENT EQUIPMENT CO.,LTD.

Add: Sunward Industrial Park, No. 1335 Liangtang Road (E), Xingsha, Changsha, Hunan, China.
Tel: +86 731 8640 7779 E-mail: marketing@sunward.cc Web: www.sunward.com.cn

SUNWARD